

P/N: FACM24V-453Y0R5

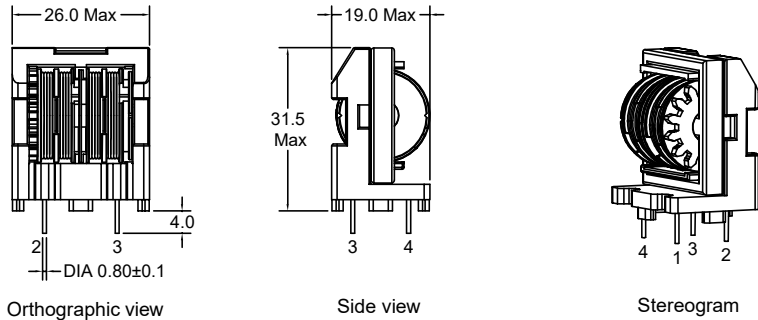

Outline Dimensions (Unit:mm)



Orthographic view

Side view

Stereogram

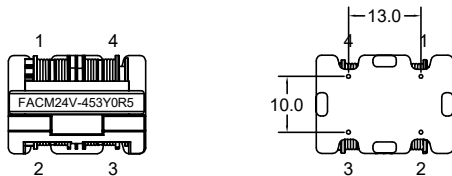

Top view

Bottom view

REMARK:  
1. Product vacuum impregnation.

Electrical Schematic

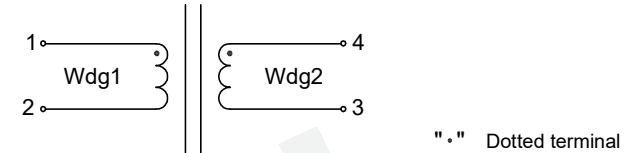

Wave Soldering

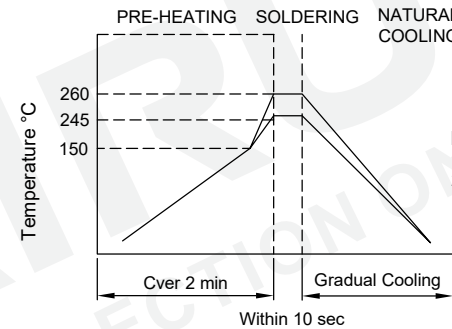

Note:  
1. Never Contact the ceramic with the iron tip;  
2. 1.0mm tip diameter(max).

Electrical Characteristics

Inductance : L1-2=4-3= 45.0mH Min,at 10KHz,0.1V.  
D.C.Resistance : 1-2= 1.500 ohms Max.  
4-3= 1.500 ohms Max.  
Rated Current : 0.500A  
Turns Ratio : Wdg1:Wdg2=1:1±1%,at 20KHz,1V.  
Hipot : Coil-Coil : 1500VAC/3mA/2S.

General Properties:

Operating Temperature:-40°C to +105°C  
(Temperature rise included).  
Storage Temperature:-25°C to +85°C.  
Storage Humidity:RH10%~70%.  
Weight:≈19.5g.

List of UL Certificate:

No.	Part Name	Mat'l Description	Supplier	UL Number
1	Bobbin	ET24-4S/PBT	Chang Chun Plastics Co Ltd	E59481
2	Base	ET24/T375J	Chang Chun Plastics Co Ltd	E59481
3	Copper wire	2UEW-F/155C	Dong Guan YiDa Industrial Co Ltd	E344055
		2UEW-F/155C	Elektrisola Hangzhou Co Ltd	E258243
4	Core	ET24 TS10	TDG Holding Co Ltd	N/A
		ET24 GH10	Su Zhou Guanda Magnet Co Ltd	N/A
5	Varnish	T-4260(a)/MW80-C	SuZhou TaiHu Electric Advanced Material Co Ltd	E228349

				Tianchang Fuan Electronic Co Ltd www.fuantronics.net TEL: +86-550-7814888 FAX: +86-550-7831133	 Tolerances unless otherwise specified: (X)±0.50 (XX)±0.25 Unit of measurement: mm	Make: Qiumei.Liu Checked: Beson. zhan Approved: Anson. zhan	<b>DRAWING TITLE</b> ET24V COMMON-CODE FILTER INDUCTOR Material Number: A24CM24VS010	Customer P/N: Document/Rev: 00 Specification Sheet: 1 of 1 Date of Recognition: Mar./13/2020
REV	DESCRIPTION	APPD	DATE					